

KENT EXCELL⁺

FOR WALL-MOUNTING/UNDER-THE-COUNTER/COOLER INSTALLATION

KENT
Mineral RO™
Water Purifiers

HOUSE of PURITY

KENT
Mineral RO™
Water Purifiers
HOUSE of PURITY

Instruction Handbook for Installation, Operation and Maintenance

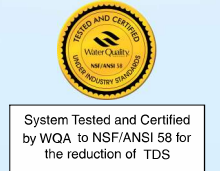
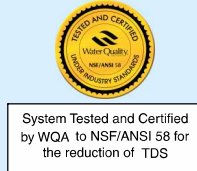

Mineral RO™ TECHNOLOGY

Removes Dissolved Impurities
Retains Essential Minerals
Multiple Purification

RO + UV + UF + TDS Control



Kent Deta Hai
**Sabse
Shudh Paani**



Marketed by:
KENT RO SYSTEMS LTD.
E-6, 7 & 8, Sector-59, Noida, U.P.-201 309, India.
E-mail: sales@kent.co.in | Website: www.kent.co.in

Manufactured by:
KENT RO SYSTEMS LTD.
1) Khasra No. 93, Village-Bantakhedi, Tehsil-Roorkee,
District-Haridwar, Uttarakhand-247 668, India.
2) A-6, Sector 87, Noida-201 305, U.P., India

For customer complaints, contact our Customer Care Officer at:
E-6, 7 & 8, Sector-59, Noida, U.P.-201 309, India. Call: 92-789-12345
E-mail: service@kent.co.in or visit us at www.kent.co.in

Reverse Osmosis Water Purifier with UV Sterilisation & TDS Controller

Mineral RO © 2005 KENT RO SYSTEMS LTD, the process & purifier is patented vide patent no. 199716.



Welcome to KENT

Dear Customer,

At the outset, allow us to thank you for your trust in KENT water purifier. We take pride in our reputation for product quality and industry proven performance. We are certain that your decision to own a KENT Excell⁺ Mineral RO™ Water Purifier will go a long way towards keeping you and your family in good health. We are confident that you will be satisfied with its performance and that it will serve your need for safe and clean drinking water without any compromise.

This guide will help you in getting the best out of your water purifier. Please go through this booklet to familiarise yourself with its operation and maintenance. In case you need any further information, contact your nearest KENT dealer/ branch.

BestWishes,

KENTROSYSTEMSLTD.

Table of Contents

1. KENT TECHNOLOGY - A Breakthrough in Water Purification	1
2. Salient Features	1
3. Items in the Box	1
4. Important Instructions	2
5. Reverse Osmosis Process	3
6. UV Process	3
7. Water Flow Diagram	4
8. Electrical Circuit Diagram	4
9. UV Fail Alarm	5
10. Filter Change Alarm	5
11. Computer Controlled Operation	5
12. Automatic Operation	5
13. Installation Instructions	6
14. TDS Adjustment	7
15. Starting up the Purifier	7
16. Recommended Usage of Rejected Water	7
17. Maintenance	8
18. Important Safety Instructions	8
19. Warning	8
20. Technical Specifications	9
21. Testing Information	9
22. Performance Data Sheet	9

KENT TECHNOLOGY- A Breakthrough in Water Purification*

Presenting the KENT Excell⁺ Mineral RO™ Water Purifier based on state-of-the-art KENT Technology, for purer and healthier water.

KENT Excell⁺ Mineral RO™ Water Purifier is a Reverse Osmosis membrane having capillaries as small as 0.0001 microns that reduce even dissolved impurities (salts and heavy metals) as well as harmful micro-organisms (bacteria, viruses, etc.) and even converts hard water into sweet and purer drinking water. It also incorporates a UV sterilisation process to give double protection from harmful micro-organisms. KENT Excell⁺ Mineral RO™ Water Purifier also allows the user to control the Total Dissolved Solids (TDS) level of purified water.

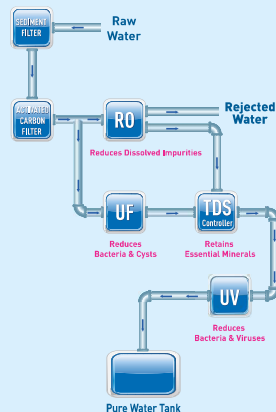





Salient Features of KENT Excell⁺ Mineral RO™ Water Purifier

- Double purification by RO + UV* processes
- In-built TDS Controller that allows adjustment of TDS level of purified water
- Suitable for purification of Brackish / Tap Water / Municipal Corporation Water Supply
- 7 L optional storage tank that makes purified water available on demand
- Fully automatic operation, with auto-on and auto-off function
- Computer-controlled operation for enhanced purity and long life
- Filter Change Alarm to indicate filter replacement time
- UV Fail Alarm* to indicate failure in UV system
- RO Membrane fused inside membrane housing to prevent tampering
- Use of push-fit fittings for leakage free and maintenance free performance

Items in the Box

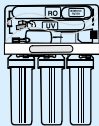
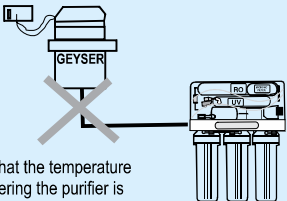
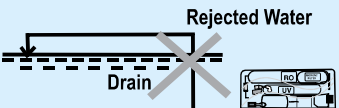
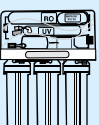
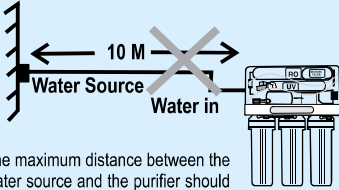
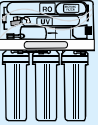
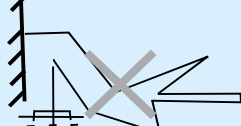
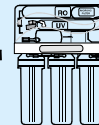
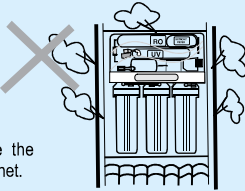
- | | |
|--|-------------|
| 1. KENT Excell ⁺ Mineral RO™ Water Purifier | : 01 N |
| 2. 3-Way Connector | : 01 N |
| 3. S.S. Ball Valve | : 01 N |
| 4. Food Grade 0.952 Cm (Blue) | : 2.5 m |
| 5. Food Grade 0.635 Cm (White) | : 2.5 m |
| 6. Food Grade 0.635 Cm (White) | : 2.5 m |
| 7. Warranty Card | : 01 N |
| 8. Screws & Plastic Inserts | : 02 N each |
| 9. Sticker Center Drill | : 01 N |
| 10. Faucet | : 01 Set |
| 11. Hydrostatic Storage Tank | : Optional |

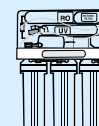
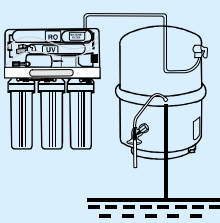
Important Instructions

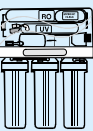
 <p>Avoid exposure to direct sunlight and installation in damp areas.</p> 	 <p>Make sure that the temperature of water entering the purifier is within 10-40° C.</p>
 <p>Rejected Water Drain</p> <p>Make sure that the rejected water pipe is not placed at a level higher from the system, otherwise rejected water may flow backwards into the purifier.</p> 	 <p>10 M Water Source Water in</p> <p>The maximum distance between the water source and the purifier should not be more than 3 meters.</p> 
 <p>Avoid sharp bends in the pipe fittings. Do not bend or block the reject water pipe.</p> 	 <p>Do not confine the purifier in a cabinet.</p>
 <p>In case of not using the purifier for more than two days, kindly switch off the power supply and drain the storage tank.</p> 	<p>To keep the storage tank clean, it should be drained once in 15 days.</p> 
<p>KENT</p>  <p>Use Genuine KENT spares for optimum performance.</p>	  <p>Do not try to service the purifier on your own. Instead, call service technician for help.</p>

* Tested & Certified by TUV-SUD South Asia (P) Ltd.

Reverse Osmosis Process

The Reverse Osmosis process, also known as hyper filtration, is the finest filtration process known till date. The process ensures reduction of particles as small as ions from a solution. Reverse Osmosis uses a semi-permeable membrane to reduce salts from potable / brackish water. In Reverse Osmosis, water pressure applied to the concentrated side forces the process of osmosis into reverse. Under enough pressure, treated water is "squeezed" through the membrane from the concentrated side to the diluted side. Salts dissolved in water as charged ions are repelled by the RO membrane. The rejected impurities on the concentrated side of the membrane are washed away in a stream of waste water and thus do not get accumulated as in a traditional filter.

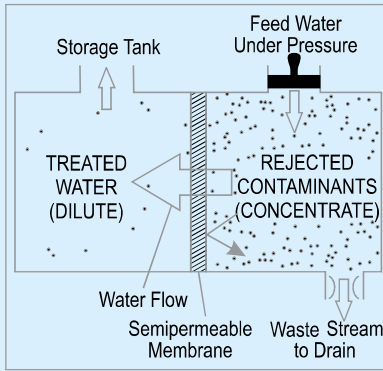

UV Process

The UV light has shorter wavelength (higher energy) than the visible light. It is called ultra-violet because it is just beyond violet light in the light spectrum. Technically, the ultra-violet light is defined to be any wavelength of light, which is shorter than 400 nanometer.

UV rays, which penetrate into the micro-organisms, are absorbed by the DNA of the pathogen in the water. The DNA is altered in such a way that the pathogen cannot reproduce itself. Thus, it is essentially killed and cannot cause infection. This process of DNA modification is called inactivation.

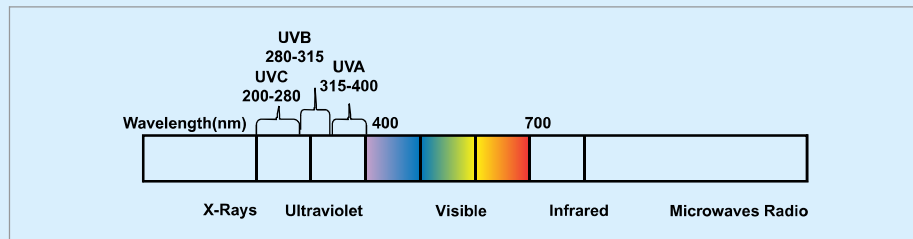

Water Flow Diagram

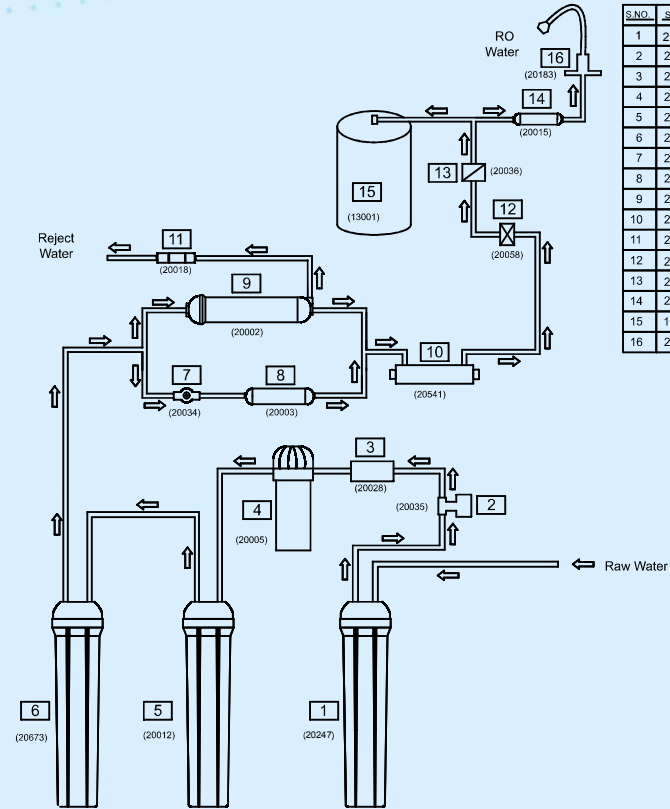

S.NO.	SP.-CO.	ITEM DESCRIPTION
1	20247	SEDIMENT FILTER
2	20035	LOW PRESSURE SWITCH
3	20028	SOLENOID VALVE
4	20005	BOOSTER PUMP
5	20012	ACTIVATED CARBON FILTER
6	20673	CARBON BLOCK FILTER
7	20034	TDS CONTROL VALVE
8	20003	UF FILTER
9	20002	RO MEMBRANE
10	20541	UV CHAMBER
11	20018	FLOW RESTRICTOR TUBE
12	20058	NON RETURN VALVE
13	20036	HIGH PRESSURE SWITCH
14	20015	POST CARBON FILTER
15	13001	HYDROSTATIC TANK
16	20183	FAUCET

Electrical Circuit Diagram

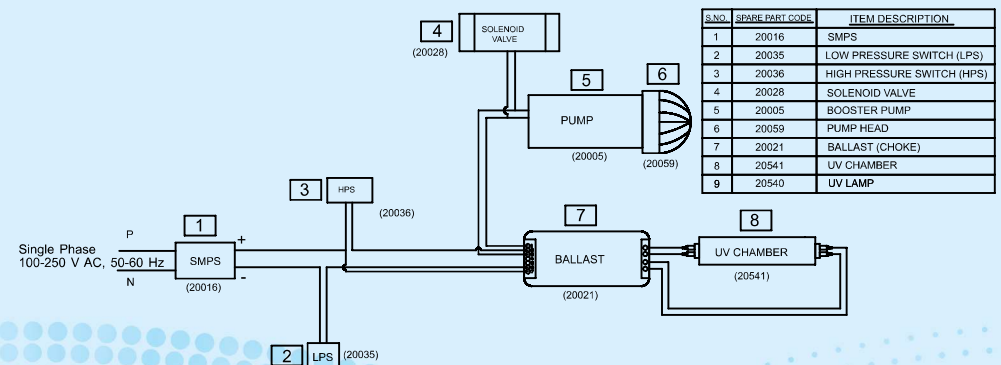

S.NO.	SPARE PART CODE	ITEM DESCRIPTION
1	20016	SMPS
2	20035	LOW PRESSURE SWITCH (LPS)
3	20036	HIGH PRESSURE SWITCH (HPS)
4	20028	SOLENOID VALVE
5	20005	BOOSTER PUMP
6	20059	PUMP HEAD
7	20021	BALLAST (CHOKE)
8	20541	UV CHAMBER
9	20540	UV LAMP

UV Fail Alarm*

KENT Excell+ Mineral RO™ Water Purifier has an in-built feature of an audible alarm if the UV lamp malfunctions. This feature is provided to ensure purity. The UV Fail Alarm will sound as following:

One short beep after every two seconds.

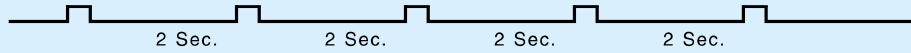

In case such an alarm is audible, kindly switch off the purifier and call the service technician for help. The purifier will stop its purification process in such a circumstance.

Filter Change Alarm

KENT Excell+ Mineral RO™ Water Purifier has an in-built feature of an audible alarm to indicate replacement time filters. This alarm will be audible after 700 hrs of use since the last filter change (or since the time of installation). The Filter Change Alarm will sound as following:

4 short beeps after every two seconds; for 30 seconds. The alarm will repeat after every 2 hours of use.

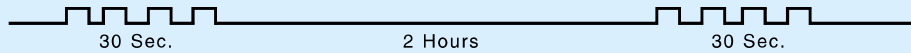

In case such an alarm is audible, please call the service technician and request him to change the filters of the purifier. However, if the filters are not changed within the next 60 hours of operation, the purifier will stop functioning to ensure purity and hygiene. The following alarm will be audible after 60 Hrs. A continuous beep for an infinite time.



In case, such an alarm is audible, kindly switch off the purifier and call the service technician to replace the filters. In such a circumstance, the purifier will not function unless the filters are changed.

Computer Controlled Operation*

To ensure delivery of purer and healthier water, a micro-processor is installed in the purifier that performs the following functions:-

UV Stabilisation Delay: To ensure that the UV lamp is pre-heated and is working at its optimum level before it starts disinfecting water, the controller provides a two seconds delay to UV lamp when the purifier is switched on. During this period, only the UV lamp is switched on and other electrical devices of the purifier are switched off.

Purification Delay: To ensure that the idle water lying in the internal pipes and in the UV chamber is disinfected before being passed into the storage tank, the system provides 5 second delay when the purifier is switched on. During this time, the UV lamp kills all micro-organisms that may be in the water inside UV chamber. After this delay, all other electrical devices such as booster pump and solenoid valve are switched on to start normal purification process.

Audible Alarm: The controller also controls the timing of UV Fail Alarm and the Filter Change Alarm.

Automatic Operation

- The purifier automatically shuts off when the storage tank is full
- The purifier automatically restarts when water level drops below the maximum
- The purifier does not start when inlet water supply pressure falls below 0.3 kg/cm²
- The purifier does not allow any water rejection in absence of electricity or when tank is full

* Tested & Certified by TUV-SUD South Asia (P) Ltd.

Installation Instructions

The KENT Excell+ Mineral RO™ Water Purifier is a product of advanced technology which ensures safe and clean drinking water. The purifier is easy and convenient to install.

Recommended Site Preparations:

- Single Phase 100-250V AC, 50-60 Hz. connection not more than 3m away from the point of installation of purifier
- Raw water supply with ½ inch nipple not more than 3m away
- Drain for rejected water not more than 3m away
- Space as per dimensions of the purifier
- Wall/plane surface for mounting two screws and holding the machine
- The system and installation needs to comply with state and local laws and regulations

Specific Instructions:

- KENT Excell+ Mineral RO™ Water Purifier is an under-the-counter RO water purifier. Make sure that it is only mounted on a wall. Avoid installation on wooden and metallic stands
- For optimum performance and minimum inlet pressure required, ensure that the raw water supply tank is at least 10 ft above the level at which the purifier is installed
- It is preferable to install the purifier near a sink so that faucet can be mounted on the sink and the inlet and reject water lines are easily available

Installation Instructions:

- Screw in the two 10x50 self tapping screws at the same horizontal level at a distance of 246 mm from each other in the wall. This can be preferably done under the kitchen sink
- Carefully hang the purifier on the wall with the help of wall mounting slot holes present on the back side of the purifier, as shown in the figure 1
- Fix the SS ball valve to the ¼ inch port of the 3-way connector
- Connect the 3-way connector to the raw water supply as shown in the figure 2. The threaded end of the 3-way connector is fitted in line with the raw water supply. The other end can be connected to a tap or can be plugged off if not required
- Now connect one end of the white pipe to the SS ball valve and other end to the inlet of the right most sediment filter (labeled as No. 1 in the system flow diagram) (Note: white pipe is for raw water supply)
- Similarly, connect one end of the blue pipe to the outlet of the flow restrictor tube (labeled as No. 11 in the system flow diagram) and leave the other end of the pipe in the drain. (Note: Blue pipe is for reject water)
- Make a drill of 11 mm on the top of the sink or kitchen bed where the faucet (labeled as No. 16 in the system flow chart) can be installed conveniently as per drawing. Secure the faucet to the sink, by tightening the brass nut washer
- Tighten the 90 degree ball valve to the tank and connect it to the outlet of the purifier as shown in the drawing

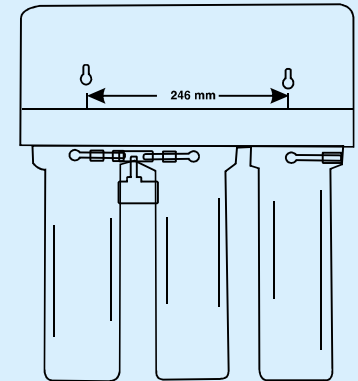

Figure 1

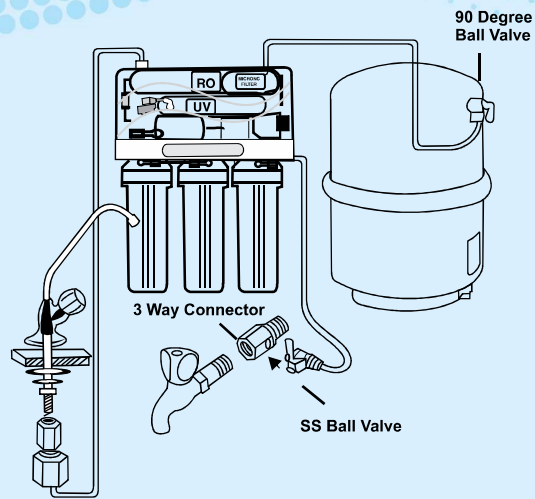

Figure 2

TDS Adjustment*

The unique TDS Controller enables customers to retain the contents of natural minerals in purified water as per their requirement.

- Turning the screw of the valve anticlockwise results in an increased mineral content
- Turning the screw of the valve clockwise results in a decreased mineral content

Starting-up the Purifier

- Switch on the power supply
- Wait approximately for half an hour so that the storage tank fully fills up**
- Switch off the power supply
- Drain off the storage tank by opening the faucet to remove any dust particles from the pipe and storage tank
- Close the faucet & switch on the power supply
- The purifier is ready to use

Recommended Usage of Rejected Water

Although the rejected water has high concentration of salts, it is absolutely clean and free of impurities like chlorine, dirt, sand, etc. which are present in raw water. This rejected water usually goes down the drain but if required, can be used for gardening purposes. It has high concentration of salts and minerals which accelerates plant growth. Rejected water can also be used for cleaning purposes, i.e. cleaning utensils, mopping, etc.

* Tested & Certified by TUV-SUD South Asia (P) Ltd.

** Tested or certified flushing time - 24hrs.

Maintenance

To ensure that the purifier operates at its optimum level, a routine maintenance must be performed. The frequency of the maintenance will greatly depend upon the raw water quality and consumption of purified water.

- Replace RO membrane once in a year
- Replace UV Lamp once in a year
- If you are not going to use the purifier for a long time (in case you are on a holiday, tour or out of home), make sure that you disconnect the power supply, turn off the raw water supply and drain the storage tank
- Replace sediment, activated carbon block and UF filter when the filter change alarm is audible OR after every 12 months. It is recommended to change the FRT when the filters are replaced

Note: Filters and membrane are consumables. Their replacement time is dependent on the quality of raw water and water consumption. They are not covered under the warranty. However, if a filter chokes within six months and a membrane within a year, it will be cleaned/repared/replaced free of cost. Changing the filters and system inspection is available on call. The purification capacity of RO membrane will reduce with time due to clogging of pores of membranes.

The reverse osmosis system contains a replaceable treatment component critical for the effective reduction of total dissolved solids and that product water shall be tested periodically to verify that the system is performing properly.

Replacement of spare parts are as under:-

-20247	SP Sediment Filter 10"
-20012	SP Activated Carbon Filter 10"
-20002	SP RO Membrane Welded 8" Housing
-20015	SP Post Carbon Filter (Blue)
-20003	SP Hollow Fibre Membrane
-20018	SP FRT 550
-20673	SP Carbon Block 10" Excell

"This reverse osmosis system contains a replaceable component critical to the efficiency of the system. Replacement of the reverse osmosis component should be with one of identical specifications as defined by the manufacturer, to ensure the same efficiency and contaminant reduction performance."

Important Safety Instructions

- If the supply cord is damaged, it must be replaced by the original part in order to avoid hazard
- Children should be supervised to ensure that they do not play with the appliance
- This appliance is not intended for use by persons (including children) with reduced physical, sensory or mental capabilities, or lack of experience and knowledge, unless they have been given supervision or instruction concerning use of the appliance by a person responsible for their safety

Warning

- Do not operate the UV-C emitter when it is removed from the appliance enclosure
- Read the maintenance instructions before opening the appliance
- The appliance must be disconnected from the supply before replacing the UV-C emitter

Technical Specifications

Product	KENT EXCELL ⁺ Without Tank
Product Code	11003
Product Generic Name	Water Purifier
Product Colour	White
Applications	Suitable for Purification of Brackish/Tap Water/ Municipal Corporation Water.
Purification Production Rate	15 L/hr.*
Body Material	ABS Food Grade Plastic/Stainless Steel
Mounting	Wall-mounting/Under-the-Counter/Cooler Installation
Dimensions (mm)	390 (L) X 200 (W) X 520 (H)
Inlet Water Pressure/Temp. (Min.)	0.3 kg/cm ² /10°C
Inlet Water Pressure/Temp. (Max.)	4 kg/cm ² /40°C
Min./Max. Operating pH	6.5-8.0
Filter Cartridge	Sediment, Activated Carbon, UF and Post Carbon.
UV Lamp Wattage	11 W
Life of UV Lamp	5000 hrs. of operation
Net Weight	10.7 kg
Storage Capacity	7 L
Maximum Duty Cycle	75 L/day
Membrane Type	Thin Film Composite RO
Booster Pump Voltage	24 V DC
Total Power Consumption	60 W
Input Power Supply	Single Phase 100-250V AC, 50-60 Hz. 
IP Rating	IPX1

* Treatment capacity tested for tap water having TDS level of 750 ppm at room temperature.

Testing Information

The System has been tested according to IS 10500:2012 (Standards for drinking water as per Bureau of Indian Standards) for reduction of the hazardous substances as listed below.

Performance Data Sheet-KENT Excell⁺ Mineral RO™ Water Purifier

"This system has been tested according to NSF/ANSI 58 for reduction of the substances listed below. The concentration of the indicated substances in water entering the system was reduced to a concentration less than or equal to the permissible limit for water leaving the system, as specified in NSF/ANSI 58".

Substance	Influent challenge concentration mg/L	Maximum permissible product water concentration mg/L	Minimum % reduction
Total Dissolved Solids	750 ± 40 mg/L	187	86.8%

"Do not use with water that is microbiologically unsafe or of unknown quality w/o adequate disinfection before or after the system".

The replacement component, 20247 SP Inline Sediment Filter 10", 20012 SP Inline Carbon Filter 10", 20002 SP RO Membrane Welded 8" Housing, 20015 SP Post Carbon Filter (Blue), 20003 SP Hollow Fibre Membrane (RO), 20018 SP FRT 550, 20673 SP Carbon Block 10" Excell Can be purchased directly from the manufacturer **KENT RO SYSTEMS LTD.**